

SEALED TRANSFORMER WITH PTC CMP SERIES

FEATURES

- CQC Approved:
CQC file No.CQC13001094903
- Vacuum Filling
- Split Bobbin Design
- Self-Extinguishing Plastics UL94V-0
- Dielectric Strength:
INPUT:230V 4200Vrms
INPUT:115V 2800Vrms
- Operation Frequency:50/60Hz
- Resin Class B IEC 85
(20,000 h Testing to IEC 216)
- 100% Production Tested

ORDERING CODE

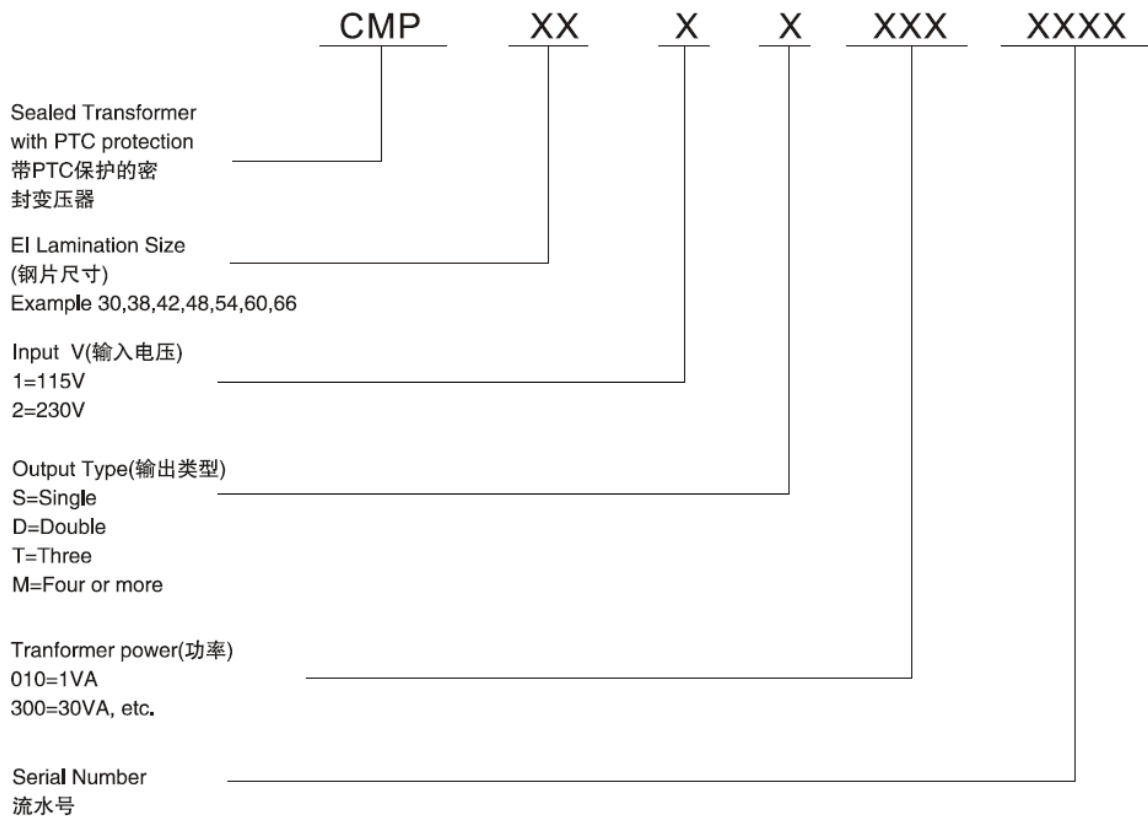

OUTLINE DIMENSIONS

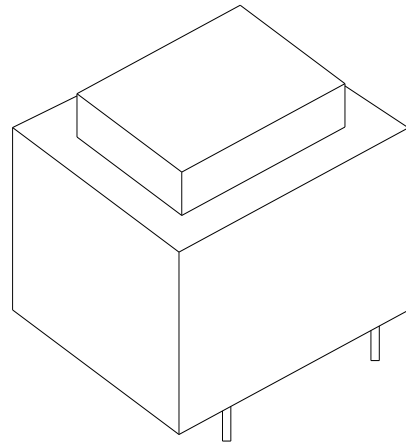
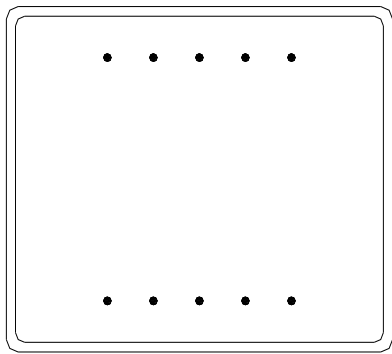
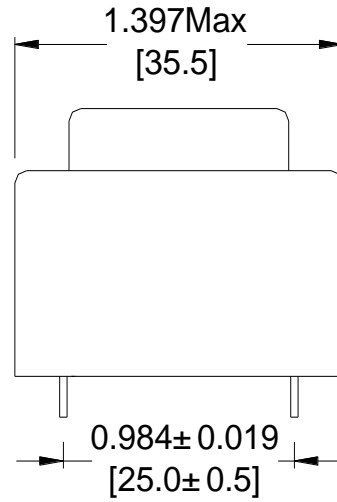
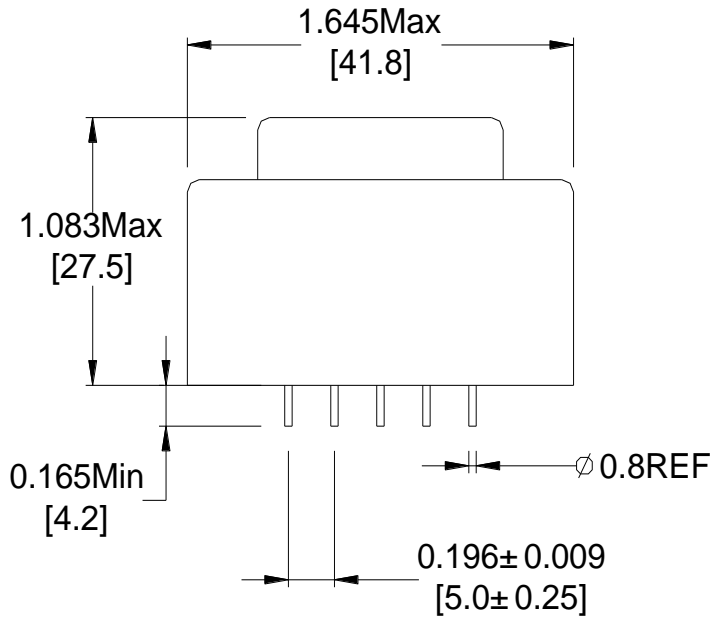

SCHEMATIC DIAGRAM:

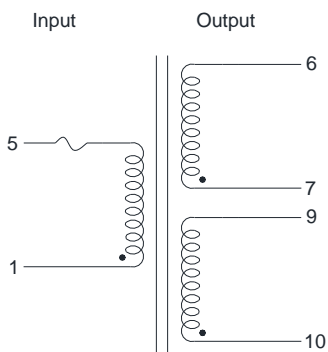

Dual outputs

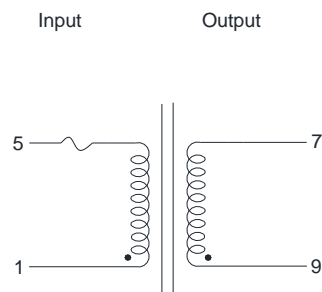

Single output

ELECTRONIC SPECIFICATIONS

Order Number	Input Voltage (Vac)	No-load Voltage (Vac)	SEC. Voltage (Vac)	Rated Current (mA)	Rated Power (VA)	Ambient TEMP. (°C)	Weight (g)	Certificate	
								CQC	CE
CMP382S0450601	220V	7.6	6	533	4.5VA	T 40 B	150g		
CMP382S0450901	220V	11.7	9	356	4.5VA	T 40 B	150g		
CMP382S0451001	220V	13.5	10	320	4.5VA	T 40 B	150g		
CMP382S0451201	220V	15.5	12	267	4.5VA	T 40 B	150g		
CMP382S0451501	220V	19.5	15	213	4.5VA	T 40 B	150g		
CMP382S0451801	220V	23.3	18	178	4.5VA	T 40 B	150g		
CMP382S0452401	220V	31.9	24	133	4.5VA	T 40 B	150g		
CMP382D0450601	220V	2X7.6	2X6	2X267	4.5VA	T 40 B	150g		
CMP382D0450901	220V	2X11.7	2X9	2X178	4.5VA	T 40 B	150g		
CMP382D0451001	220V	2X13.5	2X10	2X160	4.5VA	T 40 B	150g		
CMP382D0451201	220V	2X15.5	2X12	2X133	4.5VA	T 40 B	150g		
CMP382D0451501	220V	2X19.5	2X15	2X107	4.5VA	T 40 B	150g		
CMP382D0451801	220V	2X23.3	2X18	2X89	4.5VA	T 40 B	150g		
CMP382D0452401	220V	2X31.9	2X24	2X67	4.5VA	T 40 B	150g		